

This copy is a reprint which includes
pages from Changes 1 thru 3

TM 55-1680-351-10

**DEPARTMENT OF THE ARMY
TECHNICAL MANUAL**

**OPERATOR'S MANUAL
FOR**

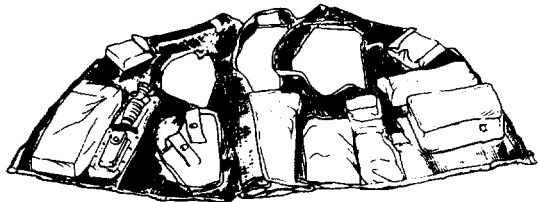

SRU - 21/P

Army Vest, Survival

(NSN 8465-00-177-4819) (Large)

(NSN 8465-01-174-2355) (Small)

This manual supersedes TM55-8465-215-10, 9June 1970

**"Approved for public release;
distribution is unlimited."**

**HEADQUARTERS
DEPARTMENT OF THE ARMY
22 APRIL 1987**

PRECAUTIONARY DATA

Personnel performing instruction Involving operation procedures and practices which are included or implied in this manual shall observe the following instructions. Disregard of warnings can cause serious injury or death.

WARNING

SIGNAL KIT, FOLIAGE PENETRATING. Do not point a loaded launcher at personnel. Personnel distress flares burn at a temperature of approximately 5000° F. and can cause serious burns, or death.

WARNING

The lensatic compass has a luminous radioactive dial and must be handled with care to prevent damage. When a lens or dial is cracked or damaged, do not handle compass without gloves and dispose of immediately by burying compass underground. Do not throw a damaged compass in a stream or lake. When exposed skin is contaminated by the luminous dial of compass, cleanse skin immediately with soap and water. Refer to TB55-1500-31425 for any additional information.

a/(b blank)

This is a reprint of change 1.

CHANGE }
No. 1

**HEADQUARTERS
DEPARTMENT OF THE ARMY
WASHINGTON, D. C., 4 NOVEMBER 1988**

**ARMY VEST
SURVIVAL**

**NSN 8465-00-177-4819 (LARGE)
NSN 8465-01-174-4819 (SMALL)**

TM 55-1680-351-10,22 APRIL 1987,
is changed as follows:

1. Remove and insert pages as indicated below. New or changed text material is indicated by a vertical bar in the margin. An illustration change is indicated by a miniature pointing hand.

Remove pages

2-11 and 2-12
2-17 and 2-18

Insert pages

2-11 and 2-12
2-17 and 2-18

2. Retain this sheet in front of manual for reference purposes.

By Order of the Secretary of the Army:

Official:

CARL E. VUONO
General, United States Army
Chief of Staff

WILLIAM J. MEEHAN II
Brigadier General, United States Army
The Adjutant General

DISTRIBUTION:

To be distributed in accordance with DA Form 12-31, -10 and CL requirements for all Fixed and Rotary Wing Aircraft.

Remove pages

Insert pages

2-5 and 2-6

2-6

2-13 and 2-14

2-13 and 2-14

A-1/A-2

A-1/A-2

2. Retain this sheet in front of manual for reference purposes.

By Order of the Secretary of the Army:

CARL E. VUONO
General, United States Army
Chief of Staff

Official:

PATRICIA P. HICKERSON
Colonel, United States Army
The Adjutant General

DISTRIBUTION:

To be distributed in accordance with DA Form 12-31-E, block no. 1368, -10 and CL maintenance requirements for TM 55-1680-351-10.

This copy is a reprint.

TM 55-1680-351-10

C 2

CHANGE }
NO. 2 }

HEADQUARTERS
DEPARTMENT OF THE ARMY
WASHINGTON, D.C., 17 JUNE 1991

Operator's Manual for SRU-21/P
ARMY SURVIVAL VEST

NSN 8465-00-177-4819 (LARGE)

NSN 8465-01-174-2355 (SMALL)

TM 55-1680-351-10, 22 April 1987,
is changed as follows:

1. Remove and insert pages as indicated below. New or changed text material is indicated by a vertical bar in the margin. An illustration change is indicated by a miniature pointing hand.

Remove pages

i and ii
1-1 through 1-5/
1-6
2-3 and 2-4

Insert pages

i and ii
1-1 through 1-5/
1-6
2-3/2-4

CHANGE
NO. 3

HEADQUARTERS
DEPARTMENT OF THE ARMY
WASHINGTON, D.C., 30 APRIL 1993

OPERATOR'S MANUAL
FOR
SRU-21/P
ARMY VEST, SURVIVAL

(NSN 8465-00-177-4819)(LARGE)
(NSN 8465-01-174-2355)(SMALL)

DISTRIBUTION STATEMENT A: Approved for public release;
distribution is unlimited.

TM 55-1680-351-10, 22 April 1987,
is changed as follows:

1. Remove and insert pages as indicated below. New or changed text material is indicated by a vertical bar in the margin. An illustration change is indicated by a miniature pointing hand.

Remove pages

iii/(iv blank)
2-1 and 2-2
2-13 through 2-16

Insert pages

iii/(iv blank)
2-1 and 2-2
2-13 through 2-16

2. Retain this sheet in front of manual for reference purposes.

By Order of the Secretary of the Army:

Official:

MILTON H. HAMILTON
*Administrative Assistant to the
Secretary of the Army*

04054

GORDON R. SULLIVAN
*General, United States Army
Chief of Staff*

DISTRIBUTION:

To be distributed in accordance with DA Form 12-31-E, block no. 1368, requirements for TM 55-1680-351-10.

TECHNICAL MANUAL
HEADQUARTERS
DEPARTMENT OF THE ARMY
WASHINGTON, D.C.

Operator's Manual For
SRU-21/P
ARMY SURVIVAL VEST

(NSN 8465-00-177-4819) (Large)
(NSN 8465-01-174-2355) (Small)

REPORTING ERRORS AND
RECOMMENDING IMPROVEMENTS

You can help improve this manual. If you find any mistakes, or if you know of a way to improve the procedures, please let us know. Mail your letter or DA Form 2028 (Recommended Changes to Publications) direct to Commander, US Army Aviation Systems Command, ATTN: AMSAV-MC, 4300 Goodfellow Blvd., St. Louis, Mo. 63120-1798. A reply will be furnished to you.

		Paragraph	Page
CHAPTER	1. INTRODUCTION		
Section	I. General		
	Scope	1	1-1
	Reporting of equipment manual improvements	2	1-2
Section	II. Description and Data		
	Description	3	1-2
	Tabulated data	4	1-3
CHAPTER	2. OPERATING INSTRUCTIONS		
Section	I. Preparation		
	Donning and fitting of vest	5	2-1
	Alteration	6	2-3
Section	II. Deleted		
Section	III. Use of Components		
	General	10	2-6
	Light, marker, distress SDU-5E, w/flash guard AGR-FGIB	11	2-7
	Signal kit, foliage penetrating	12	2-8
	Mirror, mark 3, type 1 emergency signaling	13	2-9
	Receiver-Transmitters, Radio, ARG-RT-10, and AN/PRC-90.....	14	2-11
	Revolver .38 caliber, special.....	15	2-12
	Tourniquet.....	16	2-12
	Compass, lensatic	17	2-12

		Paragraph	Page
	Survival kit, ind., tropical	18	2-13
	DELETED		
	Knife, pocket	20	2-15
	Bag, water, size B	21	2-15
	DELETED		
	Blanket, combat casualty	23	2-16
	Whistle, ball, plastic	24	2-17
	Fire starter, magnesium bar	25	2-17
	Assembly instruction sheet	26	2-17
	TM 5598465-351-10.....	27	2-18
	Suggested Publications.....	28	2-18
CHAPTER	3. RADIO SET AN/PRC-90		
Section	I. Controls and Instruments		
	Equipment Damage and Warnings	29	3-1
	Operator Controls	30	3-2
Section	II. Operation Under Usual Conditions		
	Preflight Procedures	31	3-7
	Modes of Operation	32	3-9
	Operational Siting and Operating Procedures	33	3-10
	Stopping Procedure	34	3-17
	Operating and Storage Limitations	35	3-18
Section	III. Operation Under Unusual Conditions		
	Operation in Desert and Tropical Areas	36	3-20
	Operation in Maritime, High Altitude, or Rainy Areas	37	3-21
	Recognition and Identifica- tion of Jamming.....	38	3-21
APPENDIX A.	REFERENCES		A-1

CHAPTER 1
INTRODUCTION

Section I. GENERAL

1. Scope

This manual, issued expressly for the aircrewmember, is the official document for the vest survival kit used with Army aircraft. The purpose of this manual is to supply the aircrewmember with the latest information on kit contents and instructions on their intended uses. Packing instructions, drawing, and this manual are stored in right, inside pocket of vest.

2. Reporting of Equipment Manual Improvements

Reporting of errors, omissions, and recommendations for improving this publication by the individual user is encouraged. Reports should be submitted on DA Form 2028 (Recommended Changes to Publications) and forwarded direct to Commanding General, U.S. Army Aviation Systems Command, (AVSCOM), ATTN : AMSAV-QRF, 4300 Goodfellow Blvd., St. Louis, MO 63120-1798.

Section II. DESCRIPTION AND DATA

3. Description

This vest survival kit is manufactured from raschel knit nylon cloth with a lacing adjustment at center back and a slide fastener at center front. Storage pockets are sewed to vest for storage of survival components. Vest can be worn with body armor, personnel parachute, and underarm life preservers. Proper donning of the vest with the above equipment is illustrated.

Change 2
1-2

4. Tabulated Data

SRU-21/P Vest Kit.

(1) Weight	7 1/2lb
(2) Dimensions	7 x 7 x 12 in. (folded)

NOTE

Holster, revolver is optional. If the vest is to be equipped with holster, revolver, it should be fitted to individual prior to installing on vest. Knife, hunting sheathed is optional item. If installed, must be positioned as shown.

Change 2

1-3

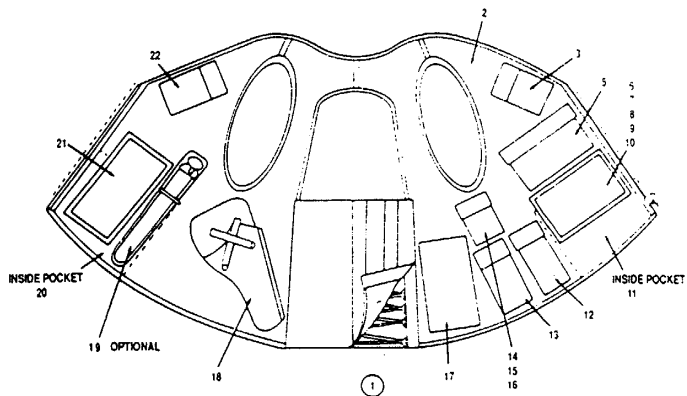

Figure 1. SRU-21 P with Components

Change 2
1-4

INDIVIDUAL SURVIVAL VEST SRU-21/P

1. SURVIVAL KIT, INDIVIDUAL, VEST TYPE SRU-2 IIP
(LARGE)
SURVIVAL KIT, INDIVIDUAL, VEST TYPE SRU-2 I/P
(SMALL)
2. . VEST, SURVIVAL, INDIVIDUAL (LARGE)
. VEST, SURVIVAL, INDIVIDUAL (SMALL)
3. .. TOURNIQUET, NON-PNEUMATIC, CAMOUFLAGE
4. DELETED
5. .LIGHT MARKER, DISTRESS SDU-5/E
.BATTERY, BA-1574/U
.FLASHGUARD, AGR-FGIB
6. . SURVIVAL KIT, INDIVIDUAL, TROP. TACT. AIRCREW
7. . MIRROR, EMERGENCY SIGNALING
8. . FIRESTARTER, AVIATION SURVIVAL, MAGNESIUM
9. . BLANKET, COMBAT CASUALTY
10. . INSECT REPELLENT, 1 OZ
11. . BAG, DRINKING WATER STORAGE: 3 PT
12. . KNIFE, POCKET
13. FIRESTARTER, AVIATION SURVIVAL, SPARK LITE
14. . CARTRIDGE, CALIBER .38 SPECIAL BALL M41
15. . CARTRIDGE, CALIBER .38 SPECIAL TRACER M41
16. . WHISTLE, BALL: PLASTIC O.D. W/LANYARD
17. . SIGNAL KIT, FOLIAGE PENETRATOR
W/LAUNCHER AND 7 FLARES L-1 19
18. . HOLSTER, REVOLVER, NYLON .38 CAL OR 9 MM
19. . KNIFE, HUNTING W/SHEATH AND
SHARPENING STONE (OPTIONAL ISSUE)
20. . ASSEMBLY INSTRUCTION SHEET AND DD FORM 1574
TAG
21. . RADIO SET, ANIPRC-90, SURVIVAL
.. BATTERY, BA-1568/U (FOR PRC-90 RADIO)
22. . COMPASS, MAGNETIC UNMOUNTED, LENSATIC
.FASTENER, SLIDE, INTERLOCKING: 15 IN. LG

Change 2
1-5/(1-6 blank)



Figure 2. SRU-21/P Vest with Underarm Flotation
2-0

CHAPTER 2
OPERATING INSTRUCTIONS

Section I. PREPARATION

5. Donning and Fitting of Vest

- a. Body armor is donned.
- b. LPU-10/P life preservers over body armor, underarm.
- c. Vest is donned and LPU-10/P life preservers are U pulled through each arm pit opening to hang over vest, underarm.
- d. Personnel parachute is donned last and is adjusted to be as free as possible from interference from components pockets on vests.

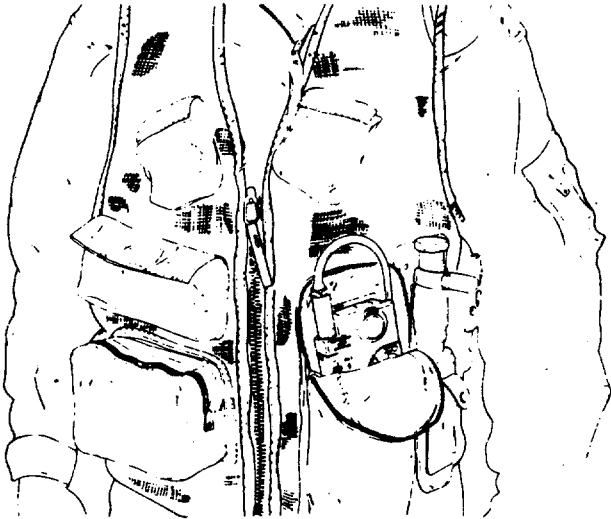

Figure 3. SRU-21/P Vest

6. Alteration

When the vest is worn over front and rear body armor, there is a possibility that the vest will be too small. When this problem arises, alteration may be accomplished per TM 55-1680-317-23&P. The alteration allows vest to be adjusted to fit anyone wearing body armor with the front and back plate installed.

CAUTION

Do not leave the drawstrings exposed during flight operations as they might become caught or hooked while trying to evacuate the aircraft.

**Change 2
2-3/(2-4 blank)**

Section II. DELETED

Section III. USE OF COMPONENTS

10. General

This section gives instructions for the use of all components contained in the vest.

 All data on pages 24 and 2-5 have been deleted.

Change 2
2-6

11. Light, Marker, Distress SDU-5E, W/Flash Guard AGR-FG1B



Figure 4. Distress Marker Light with Flashguard

The distress marker light when activated, produces an intermittent flash of light visible for a minimum distance of 5 miles and will operate completely

submerged in water. Also provided is a flash guard which may be used for directional aiming of the light. Flash guard is equipped with a blue lens so that flashes can be distinguished from gun fire flashes.

NOTE

Use flash guard with the distress marker light when in a combat zone. Check the marker light for operation before departing on a mission.

12. Signal Kit, Foliage Penetrating

WARNING

Do not point a loaded launcher at personnel. Personnel distress flares burn at a temperature of 5000° F, and can cause serious burns or death.

The signal kit, M-201, consists of a rocket launcher and seven red flares. Flares will reach an altitude of 1100 feet when fired and have a burning time of 9 seconds. Flare is visible for 2 or 3 miles in daylight

and for 10 miles at night. Remove flares from plastic retainer and insert the same end into launcher. Hold projector firmly in hand, point straight up and pull knurled knob down with thumb. Release trigger with a sharp sudden motion.

CAUTION

After flare is installed in launcher, do not pull back on knurled knob unless you are ready to fire flare.

13. Mirror, Mark 3, Type 1 Emergency Signaling

The emergency signaling mirror provided in the vest is a glass type, mark 3. To use this mirror, proceed as follows:

- a. Hold mirror so that sunlight will reflect on a nearby surface such as the hand or some other close object.
- b. Bring the mirror up to eye level and look through the sighting device until an intensely bright spot is located. This is the aim indicator.

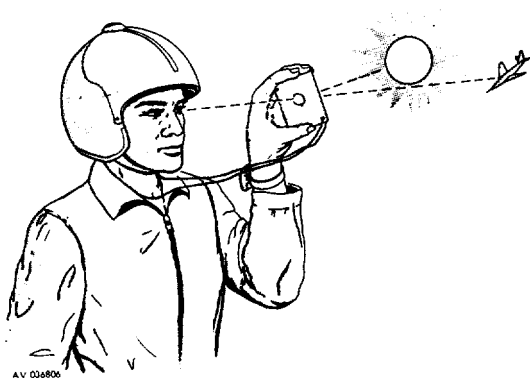

Figure 5. Emergency Signaling Mirror

- c. Hold the mirror close to the eye and slowly turn it until the bright spot is on the target.

NOTE

Mirror flashes can be sighted with good visibility for a distance of 30 miles at an elevation of 10,000 feet. Mirror flashes are also effective on cloudy days with poor visibility.

14. Receiver-Transmitter, Radio ARC-RT-10

To operate the ARC-RT-10, pull the antenna all the way out until the base ring is visible. To transmit voice, push transmit lever in, hold speaker microphone close and speak in a normal voice. To transmit and monitor tone, push transmit lever in and hold, then push tone button down to stop. The battery provided will operate the receiver-transmitter approximately 30 hours at 68° or 15 hours at 32° on a duty cycle of approximately 50% transmit and 50% receive. Range of radio for line of-sight operation is approximately 20 mile for homing and 10 miles for voice contact.

NOTE

For maximum transmit and receive, keep hands away from antenna when the radio is in operation and hold in a vertical position with serial pointed straight up.

15. Revolver, .38-Caliber, Special

Vest will accommodate a .38-caliber revolver, 17 rounds ball ammunition, and 6 rounds tracer ammunition. Weapon is for protection in a combat zone and can be utilized in the hunting of game for food. Tracer ammunition can be used to assist search personnel in pinpointing a survivor's location.

16. Tourniquet

Stow tourniquet with 8-10 inch loop for one handed manipulation. For use in case of serious injury or wound by applying pressure at a point to restrict the flow of blood. Can be used to wrap a sprained ankle, wrist, or elbow.

17. Compass, Lensatic

The magnetic compass can be your most valuable piece of equipment when traveling. In the jungle for example, most travel should be done with the compass in your hand, since it will be the only means of maintaining direction. The dense vegetation will obscure prominent landmarks and celestial aids. At night the compass is even more valuable. With the

lensatic compass, set your course by setting the azimuth of your desired course under the stationary index which is viewed through the lens. Turn the glass cover until the long luminous line is over the north arrow. To use the compass after it has been set, open the compass and rotate the entire compass until the luminous line is again over the north arrow. Your desired course will be on a line drawn through the sights.

18. Survival Kit, Ind., Tropical

Survival kit, Ind. Tropical aircrew kit consists of medical and survival components.

a. Medical items are as follows:

(1) Pain killer tabs, aspirin tablets 1 or 2 tablets every 4 hours up to 4 times a day-headache & acute pain.

(2) Anti-malaria tabs-chloroquine and primaquine and phosphate tablets take 1 tablet per week, with or after food-swallow-DO NOT CHEW for malaria prevention.

(3) Anti-diarrhea tabs-diphenoxylate hydrochloride and atropine sulfate tablets take 2 tablets 3 or 4 times daily for diarrhea.

(4) Antiseptic solution providone-iodine solution apply to skin as required, for insect bites rub in. Fungus infections, cuts, bites and scratches.

b. Survival components are as follows:

- (1) Headnet and mitten set
- (2) Compass
- (3) Saw, Flexible
- (4) Matches safety humidity resistant
- (5) Soap, toilet
- (6) Bag, food sample carrying water wrapping food, protecting valuables from water and moisture.

c. Kit, container, has written instructions on its outer surface covering medical and survival components within.

19. DELETED

20. Knife, Pocket

Knife is equipped with a screwdriver and two blades, can be used to clean and prepare small game for eating, and also to construct traps for catching small game as described in pamphlet stored in survival kit packet.

21. Bag, Water, Size B

Water bag is used to store water recovered from lakes, streams or trapped rain water. Use water purification tablets as described in survival pamphlet prior to drinking.

22. Deleted

23. Blanket, Combat Casualty

Blanket combat casualty is a thin aluminum foil sheet with international orange or O.D. plastic coloring on one side and polished aluminum on the reverse side, measures 96 inches long by 56 inches wide, used as a signaling panel, to reflect heat from fire or body heat when wrapped around individual.

*U.S. GOVERNMENT PRINTING OFFICE: 1993-757-882/60332

24. Whistle, ball, plastic

The whistle is used for attracting rescue parties at night or in foggy weather. The sound of the whistle can reach a far greater distance than your voice and requires less energy to attract attention to yourself.

25. Fire starter, magnesium bar

This is used to start a fire. Assemble tinder and scrape magnesium into tinder, making a collection of shaving about the size of a quarter, then use the sparking device side of the tool and scrape rapidly with pocket knife causing the sparks to ignite the pile and starting the fire.

26. Assembly Instruction Sheet

A 9" x 12' reproduction of the vest drawing, listing all components by FSN and their location on the vest is located in the left-hand inside pocket of the vest.

27. TM 55-1680-351-10

Operator's manual TM55-1680-351-10 is stored in the right-hand inside pocket of the vest.

28. Suggested Publications

Deleted.

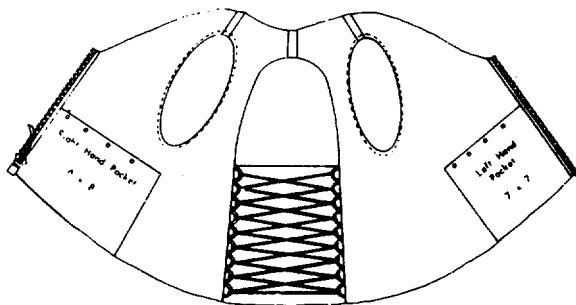

Figure 6. Inside View of Survival Vest

GPO : 1993 0 - 342-421 (63057)

Change 1
2-18

CHAPTER 3
RADIO SET, ANIPRC-90

Section I. CONTROLS AND INSTRUMENTS

29. Equipment Damage and Warnings

Radio Set AN/PRC-90 is built with ultimate operator convenience as a goal and includes provisions for safe operation without limits on control settings.

WARNING

Operation of the AN/PRC-90 without adequate rf shielding is prohibited except during a bonafide emergency situation. Keep the function switch in the OFF position at all times when not in emergency use and operate the VOL control in the minimum position during voice transmissions. Failure to observe these precautions will shorten battery life and could result in equipment failure or disrupt actual search missions. If the unit is issued in a sealed container, do not break the seal until the emergency conditions have stabilized.

30. Operator Controls

Controls and connectors for the AN/PRC-90 are shown in table 3-1.

Table 3-1. Controls, Indicators, and Connectors

Control, Indicator, or Connector	Function
Function switch (4-position rotary switch)	Selects transceiver operating mode and turns radio set off.
SW Pos OFF	Function Removes power from radio set.
VOICE/MCW 243.0	Turns receiver on for reception of 243.0 MHz voice or MCW signals. Also permits 243.0 MHz voice or MCW trans- mission when keyed by PUSH TO TALK or MCW buttons.
BCN 243.0	Turns on 243.0 MHz transmitter, and transmits a beacon tone. Swept audio tone is continuously transmitted for rescue aircraft to home on.
VOICE 282.8 (function switch but- tons must be pressed to place switch in VOICE 282.8 posi- tion)	Turns receiver on for reception of 282.8 MHz voice signals. Also permits 282.8 MHz voice trans- mission when PUSH TO TALK button is pressed.

Table 3-1. Controls, Indicators, and Connectors (Cont)

Control, Indicator, or Connector	Function
Function switch arrow/ pushbutton PUSH TO TALK button	<p>Indicates operating mode selected and locks out VOICE 282.8 position unless pressed.</p> <p>When pressed, turns receiver off and turns transmitter on when function switch is <i>in</i> either VOICE/MCW 243.0 or VOICE 282.8 position. Best voice transmissions are obtained when spoken directly into the TALK microphone. When released, turns off transmitter and turns on receiver; received signal is heard from the LISTEN speaker or earphone.</p>
MCW button	<p>This button can be used as a telegraph key to transmit morse code when normal voice transmission may reveal operator's position. MCW is only available when the function switch is in the VOICE/MCW 243.0 position. When MCW button is pressed, the radio set transmits a continuous tone, receiver is off. When button is released, transmitter is turned off, receiver is turned on.</p>
VOL control	<p>This controls the sound level from the LISTEN speaker or earphone. It controls received signals, not sidetone. When the control is fully up in the MAX position, greatest level of sound is heard; when fully turned down, lowest level of sound, but radio set is not turned off. Control setting does not affect transmitter output.</p>

Table 3-1. Controls, Indicators, and Connectors (Cont)

Control, Indicator, or Connector	Function
LISTEN speaker	Sound of received signal is heard; also the sound of MCW or beacon transmitter (sidetone) may also be heard. The LISTEN speaker is shut off when the earphone is connected.
TALK microphone	Picks up voice being transmitted when PUSH TO TALK button is pressed and function switch is set to VOICE/MCW 243.0 or VOICE 282.8 position.
EARPHONE JACK (connector)	Provides connection for earphone. When earphone is connected, LISTEN speaker is shut off, and sound is heard from the earphone.
Antenna receptacle (connector)	Provides connection for radio set antenna.
Battery cap	Holds battery in place and also externally seals battery compartment.

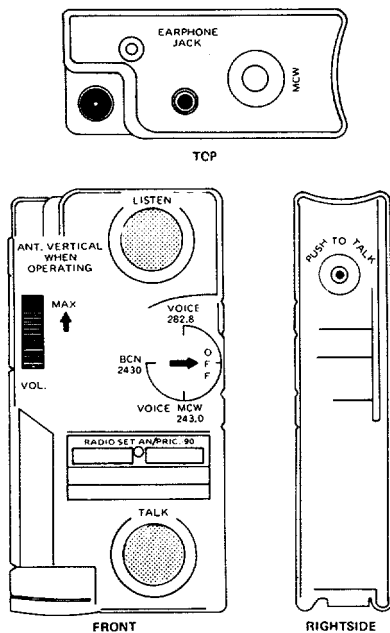

Figure 7. Radio Set AN/PRC-90, Controls and Indicators

Section II. OPERATION UNDER USUAL CONDITIONS

31. Preflight Procedures

Perform the following steps prior to use for each Radio Set AN/PRC-90.

WARNING

**Leave the function switch in the OFF. position.
Refer to paragraph (1) Unauthorized personnel
shall not perform maintenance on the AN/PRC-
90.**

a. Unscrew battery cap and remove battery, if installed. Check date of manufacture stamped on battery. Battery BA-1568/U has a maximum shelf life of 3 years in temperate climates and a ma/hr rating of 1,000 (approximately 14 hours of operation maximum in beacon mode). Discard batteries more than 3 years old. Check for evidence of battery leak- age or corrosion and condition of copper spring contacts. Install a good battery, if required, and screw battery cap on fingertight.

CAUTION

Be sure radio set antenna is installed and telescopic sections fully extended before operating radio set. Failure to do this can damage the radio operating capabilities.

b. Check receiver operation only by releasing the antenna from stored position, and fully extending telescopic sections; setting function switch to either VOICE 282.8 or VOICE/MCW 243.0 position; and setting VOL control towards MAX position. Proper receiver operation will be indicated by a slight hissing sound in the MAX position. Presence of squealing, "motorboating", or other abnormal sound (other than normal AM static interference) is an indication of malfunction. Turn function switch to OFF position.

WARNING

Do not operate MCW or PUSH TO TALK switches.

c. Check for evidence of obvious structural damage such as cracked case, perforated seals, or presence of salt, sand, or oil accumulations.

- d. Check for presence of earphone and check earphone case and cover.
- e. If deviations are noted, take required corrective action.
- f. Replace antenna in stored position, replace in normal stowage or flight suit in accordance with latest directives.

32. Modes of Operation

a. General. Radio Set AN/PRC-90 will be used only for emergency (and/or tactical) communications.

The radio can be expected to perform properly, assuming normal maintenance has been kept current.

b. Operational Modes.

The following operational modes are available:

- (1) Beacon mode. Used initially on 243.0 MHz.
- (2) MCW mode. Used for transmitting modulated continuous wave codes (MCW) as required on 243.0 MHz.
- (3) Voice mode. Used for two-way transceive communication with air, sea, or ground radios on 243.0 MHz. 282.8 MHz can be used as an alternate voice channel as directed.

33. Operational Siting and Operating Procedures
--

a. General. General instructions for correct handling of the AN/PRC-90 are provided below. Specific instructions are included in subparagraph b.

(1) The AN/PRC-90 is normally used as a beacon transmitter which transmits a continuous, "down-going beeper" AM signal for approximately 14 hrs. Whenever possible, the radio is placed on a high point, free of obstructions, and left in the BCN 243.0 mode until search aircraft or other vehicles approach. The antenna should be vertically oriented (perpendicular to the search vehicle radio) as shown in figure 9.

(2) If a search vehicle appears near the operator he may use one of two voice channels or transmit international Morse Code (MCW) to communicate with the search vehicle.

(3) When informed that a firm location has been determined, the radio can be used to communicate with other crewmen to join forces for recovery operations.

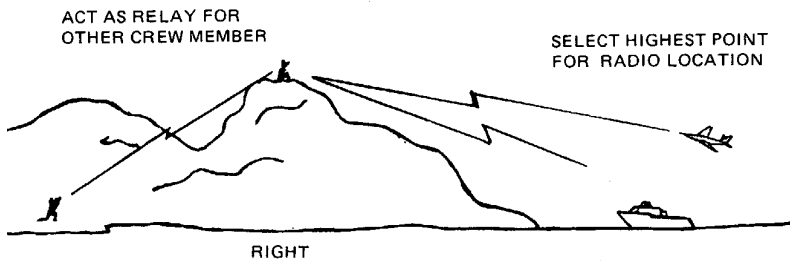
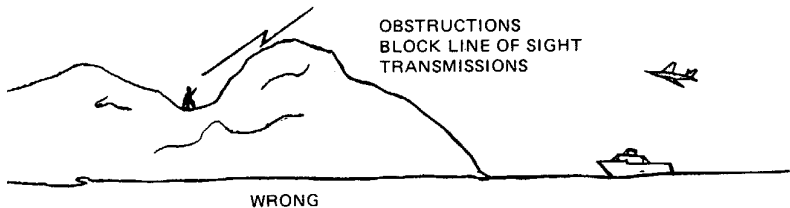

Figure 8. Operational Siting Under Search Mission Conditions.

(4) If the radio is being used for tactical operations only, use the earphone when enemy forces are near enough to hear the speaker. Keep transmissions brief in all tactical operations.

b. Emergency or Tactical Operation. Operate the equipment as follows.

(1) Remove protective cover.

(2) Select highest exposed point (hills, trees, rooftops, or uppermost portion of airframe) and set radio in a secure and upright position with the antenna pointing upwards. Avoid antenna proximity to metal uprights, nearby antennas, or rock formations which may contain conducting minerals. If in the water, keep unit and antenna as high as possible above water level and keep the antenna connector and frame area as dry as possible.

(3) Set the function switch to the BCN 243.0 position (clockwise).

WARNING

Leave the radio in the BCN 243.0 position until search planes, ships, or vehicles appear in the immediate vicinity. Failure to do so will interfere with direction-finding equipment and could result in termination of search activities. Continue this mode for at least 14 hours or until search vehicles are contacted. Battery and beacon failure is indicated by loss of beacon sidetone in the speaker (or earphone). If more than one AN/PRC-90 is available, use only one at a time and share batteries to extend the transmission period.

(4) Prior to visual contact with search craft, and if reasonable doubt exists as to proper beacon operation, occasional brief voice or mew ("Mayday" or "SOS") transmissions can be made. Limit such transmissions to daylight hours for best propagation. Follow a 2-minute-on, 1-minute-off; 3-minute-on, 2-minutes off; and 10-minute-on procedure. Make the "Mayday" and/or "SOS" transmissions once just after sunrise, once at noon, and once near sundown to take advantage of improved propagation. Meteorological conditions will affect transmission range and quality.

NOTE

Direction finding in this mode is difficult. The primary purpose is to ensure continued search operations. Battery life is reduced to an extent by voice or mew operation.

To transmit VOICE or MCW, set the function switch counterclockwise to the VOICE/MCW 243.0 position and either verbally repeat the word "Mayday" at 2 or 3 second intervals by pressing the PUSH TO TALK pushbutton or send coded "SOS" by pressing the MCW pushbutton (modulated carrier wave). Set the VOL control to the MAX position.

NOTE

Attempt to make the code ("SOS") sidetone well defined and rapid enough for experienced operators to easily recognize the code. It will have a "di-di-dit, dah-dah-dah, di-di-dit" sound with spacing between groups. Refer to the code explanation on the rear panel.

(5) If reasonable doubt exists that 243.0 MHz transmitter is functioning, set the function switch to the VOICE 282.8 position and transmit speech only as described in step (4) above.

NOTE

The function arrowhead button must be pressed to release the switch for 282.8-MHz operation.

(6) Repeat steps (1 through (3) above.

(7) When a rescue craft is within sight, call the rescue radio operator as follows. Turn the function switch clockwise to the VOICE/MCW 243.0 position and use the calling procedure outlined in table 3-2. Press the PUSH TO TALK button and speak in a normal voice near the microphone during transmissions. Do not shout. This procedure will result in a more legible transmission. Place the VOL control in a position that provides adequate audio volume from the speaker (or earphone>.

Table 3-2. Recommended Voice Operating Practices

Originating Call (AN/PRC-90)
 "CQ rescue craft, CQ. CQ,
 CQ. Over."

If no reply received, continue to call "CQ" on voice or MCW at intervals until reply is received.

"Roger, roger. Crew status follows. Over." (Report crew physical status, missing crew members, and any emergency logistics or medical requirements.)
 "Roger. Out."

Probable Reply
 None or "Roger, roger, roger." Read you five by five (or other signal report).

"Roger. Your transmission understood. Standby for reply. Out." (Or other pertinent reply).

35. Operating and Storage Limitations
--

a. Operation of the AN/PRC-90 will span a wide range of weather extremes. Although the AN/PRC-90 circuits are operable over a temperature range of -30° to $+50^{\circ}\text{C}$. (-22° to $+122^{\circ}\text{F}$.), the battery (BA-1568/U) power supply is only effectively operable over a 0° to $+54^{\circ}\text{C}$. ($+32^{\circ}$ to $+129^{\circ}\text{F}$.) temperature range. Operating at low temperature reduces battery life. The AN/PRC-90 (less the battery) may be stored over a temperature range of -60° to $+60^{\circ}\text{C}$. (-76° to $+140^{\circ}\text{F}$.).

b. Equipment operated at low temperatures should be kept in low temperature storage when not in use. Store the equipment in a shipping carton and cover the carton with water-repellent material.

c. When the equipment is to be operated at freezing temperatures, perform the following procedure before operating the equipment.

NOTE

When operational conditions using Battery BA-15681UR include temperatures below 50° F., the radio set and spare battery should be carried inside flight clothing to prevent cold soaking. The battery will not supply sufficient power to operate the radio if permitted to cold soak for extended periods of time at freezing or below freezing temperatures. Therefore, the user should initiate use of radio at low temperatures with a battery that has been warmed. Batteries should be rewarmed as soon as possible after use to insure reliable operation of the radio. The following exposure times of the battery at the temperatures indicated are recommended:

Temperature (°F)	Cold soak time
Plus 32°	30 minutes
0°	15 minutes
Minus 40°	5 minutes

(1) Keep the equipment in low temperature storage when not in use.

(2) Use water-repellent material (SB 38-100) to cover the shipping carton during periods of high humidity.

Section III. OPERATION UNDER UNUSUAL CONDITIONS

36. Operation in Desert and Tropical Areas

a. Desert Regions. Before using the equipment in desert regions, remove all sand and dust. Blow and shake sand out of speaker and microphone.

b. Tropical Regions. In climates of high humidity, such as tropics, inspect the equipment daily for fungus, mold, insects and metallic corrosion.

CAUTION

Do not open the AN/PRC-90 case chassis. Only higher category maintenance personnel may work on components. Opening the case will permit moisture and dust to enter the unit, resulting in a possible malfunction.

**37. Operation in Maritime, High Altitude,
or Rainy Areas**

Keep the AN/PRC-90 in a dry area if possible. Avoid rigging any cover materials near the antenna in salt atmosphere. Watch for accumulations of salt between the antenna base and the radio. Remove any fouling sediment to assure proper operation. No special procedures are required for high-altitude operation.

**38. Recognition and Identification of
Jamming**

Under tactical conditions, the AN/PRC-90 may be jammed by the enemy. This jamming may be planned or accidental and will usually be caused by a strong signal transmitted on the same frequency as that being used. The signal being transmitted may be a steady carrier or a modulated carrier. When it becomes difficult or impossible to receive the desired signal, switch the function switch to the alternate voice channel or revert from the voice to the MCW mode and attempt CW contact.

APPENDIX A

REFERENCES

TM 21-76	Survival, Escape, and Evasion
TM 55-1680-317-23&P	Maintenance Manual for Army Aircraft Survival Kits

**Change 2
A-1/(A-2 blank)**

By Order of the Secretary of the Army:

JOHN A. WICKHAM, JR.
General, United States Army
Chief of Staff

OFFICIAL:

R. L. DILWORTH
Brigadier General, United States Army
The Adjutant General

DISTRIBUTION:

To be distributed in accordance with DA Form 12-31, -10 and CL requirements for All Fixed and Rotary Wing Aircraft.

☆GPO: 1995 0 - 400-279

RECOMMENDED CHANGES TO EQUIPMENT TECHNICAL PUBLICATIONS

 <p><i>THEN... JOT DOWN THE DOPE ABOUT IT ON THIS FORM. CAREFULLY TEAR IT OUT, FOLD IT AND DROP IT IN THE MAIL.</i></p>				<h2>SOMETHING WRONG WITH PUBLICATION</h2>									
				FROM: (PRINT YOUR UNIT'S COMPLETE ADDRESS)		DATE SENT							
PUBLICATION NUMBER		PUBLICATION DATE		PUBLICATION TITLE									
<p>BE EXACT PIN-POINT WHERE IT IS</p> <table border="1"> <thead> <tr> <th>PAGE NO.</th> <th>PARA-GRAPH</th> <th>FIGURE NO.</th> <th>TABLE NO.</th> </tr> </thead> <tbody> <tr> <td style="height: 400px;"></td> <td></td> <td></td> <td></td> </tr> </tbody> </table>				PAGE NO.	PARA-GRAPH	FIGURE NO.	TABLE NO.					<p>IN THIS SPACE, TELL WHAT IS WRONG AND WHAT SHOULD BE DONE ABOUT IT.</p>	
PAGE NO.	PARA-GRAPH	FIGURE NO.	TABLE NO.										
<p>PRINTED NAME, GRADE OR TITLE AND TELEPHONE NUMBER</p>				<p>SIGN HERE</p>									

DA FORM 1 JUL 79 2028-2

PREVIOUS EDITIONS ARE OBSOLETE.

P.S.—IF YOUR UNIT WANTS TO KNOW ABOUT YOUR RECOMMENDATION MAKE A CARBON COPY OF THIS AND GIVE IT TO YOUR HEADQUARTERS.

PIN: 061662-000